

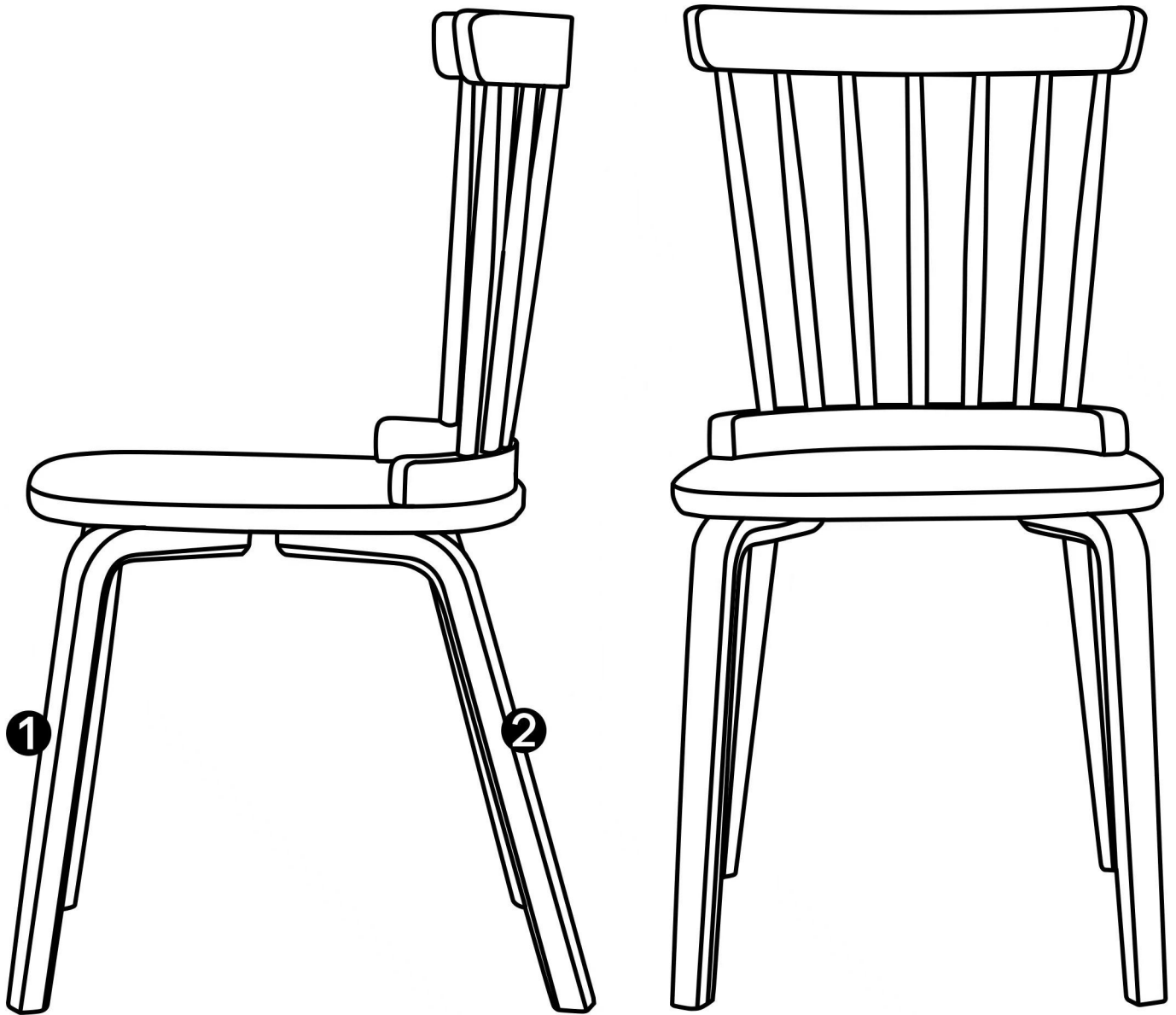

Assembly Instruction

Wood Dining Chairs

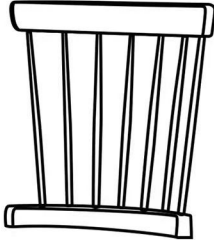
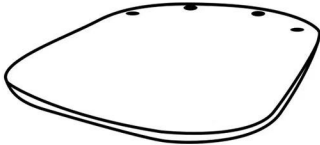
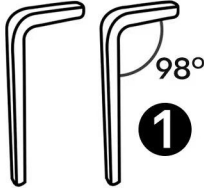
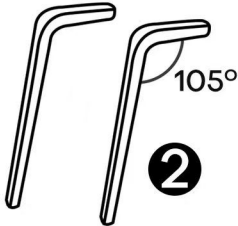
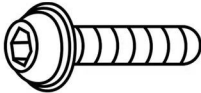

Classic Windsor chair style, combining modern and classic, with tough lines and versatile styles. With the solid wood seat as the center of the structure, the legs of the chair are directly connected to the seat surface below the seat surface. The seat back and seat surface fully consider ergonomics, and it is comfortable and safe to sit.

Parts List

Numbering	Name	Part	Qty
A	Back		x1PC
B	Seat		x1PC
C	Front Legs 98°degrees		x1PAIR
D	Back Legs 105°degrees		x1PAIR
E	Bolts M8x40mm		x12PCS
F	Allen Wrench		x1PC

Installation Guide

Please follow the instructions step by step to assemble your Windsor Dining Chair. Note: Please pay attention to the sequence of the steps.

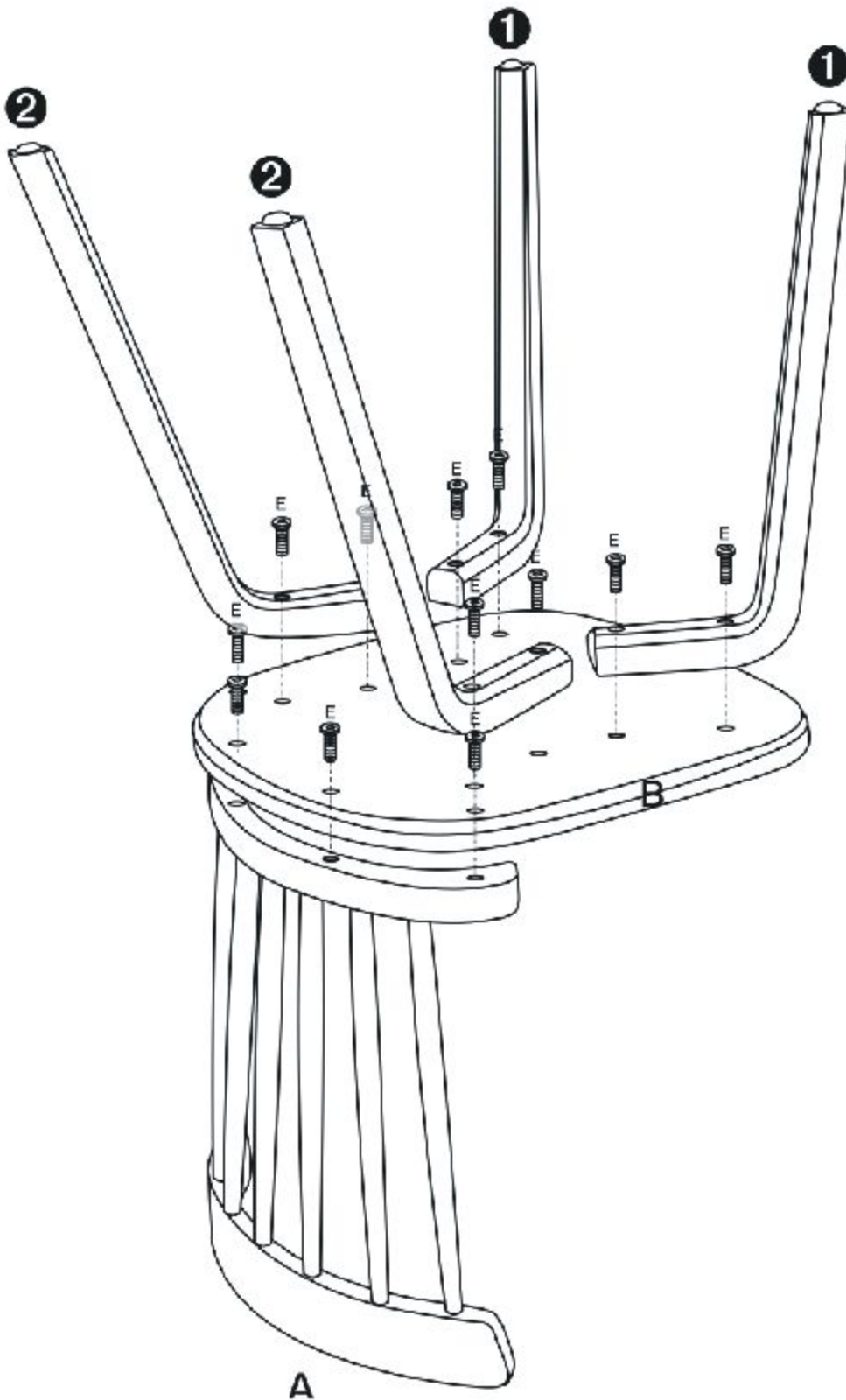

Step 1

Attach the Back Rest (Part A) to the Seat (Part B) with 4 Bolts (Part E). Fasten by the Allen Wrench (Part F)

Step 2

Attach the Fronts Legs (Part C ①) to the Seat bottom where marks ①, the Back Legs (Part D ②) to the Seat bottom where marks ② with 8 Bolts (Part E). Fasten by the Allen Wrench (Part F).

Step 3

Place the assembled chair upright and it's ready to use.