

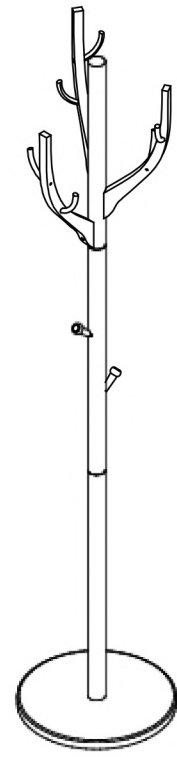

Installation instruction



J x 1



G x 1



H x 1



A x 1



8*60mm
B x 2



4*30 mm
C x 6



Non-slip mat
D x 4



6*35 mm
E x 3



F x 3

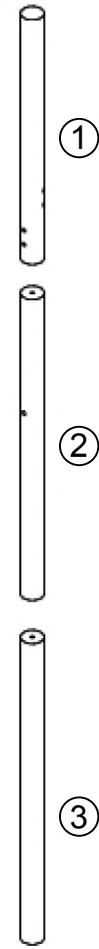
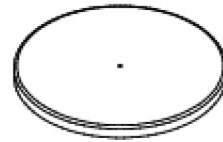
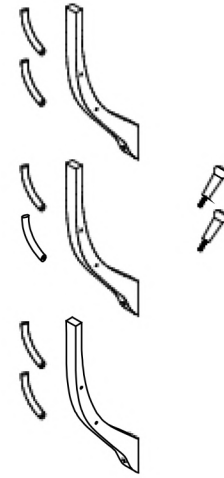

STEP 1

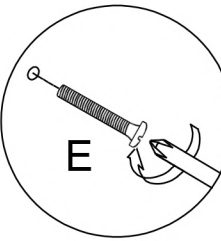
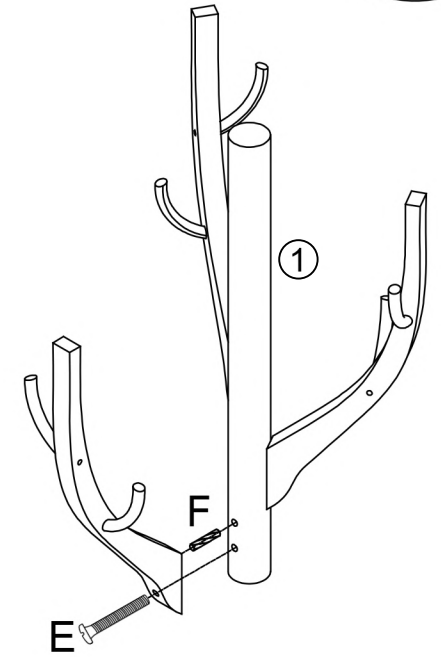
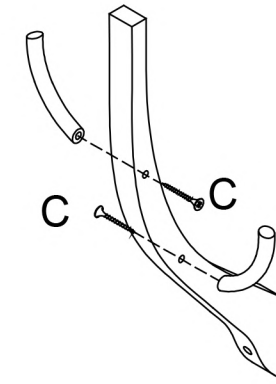

The installation method for the three corners is the same

STEP 2

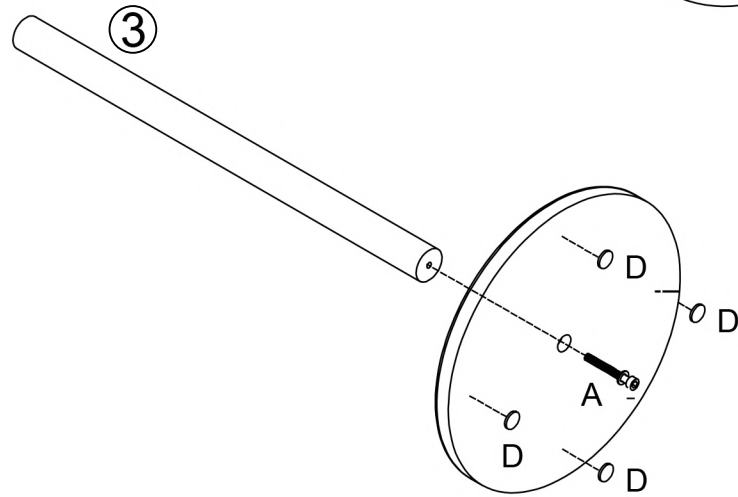
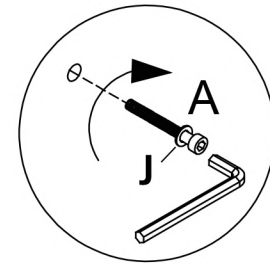

STEP 3

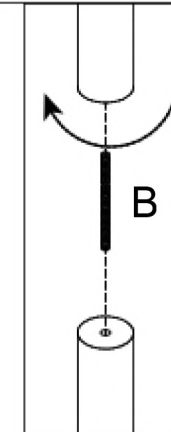
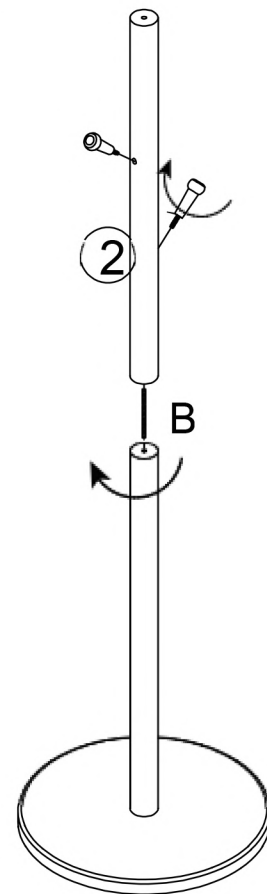

STEP 4

